

Technical Data Sheet

WEISS™

FV150

ClearFlow 150mm Through Wall

150mm ducting

Dimensions

Cut-out size for inlet fascia	155mm
Cut out size for outlet vent	155mm

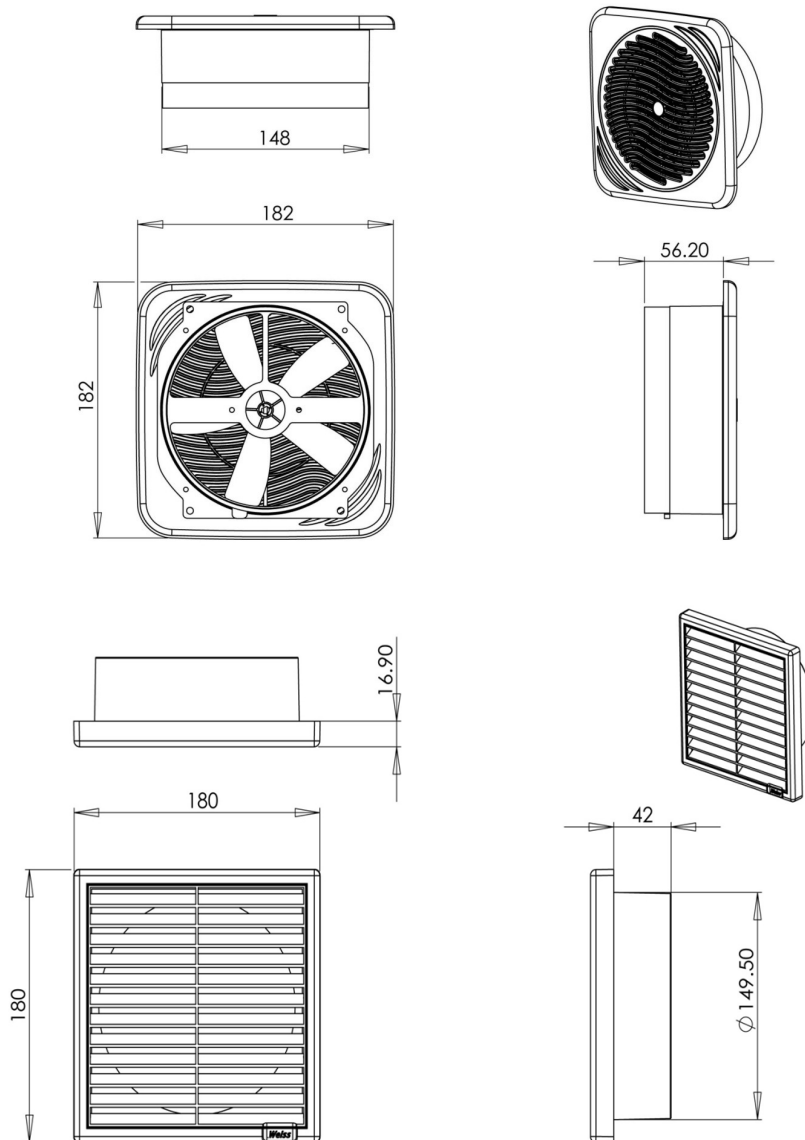

Specifications

Weight	1.1kg
Colour of front fascia	White
Housing material	ABS

Approval

AS/NZS 3350.2.80:1998 Amdts 1-3 "Electrical Fan"

Features

- Easy to install
- Fits up to 300mm wall cavity
- Unique 'no fuss' all in one unit
- Allows moisture to be removed to the outside of your home
- All parts are included
- 3 year extended warranty

Technical Data Sheet

Product Use

The FV150 is used for the extraction of mist and steam

Typical applications:

- Bathrooms
- Toilets
- Laundries

Environmental Conditions

Operation	to IEC 721-3-3
Climatic conditions	class 3K5
Temperature	0...+50°C
Humidity	<95% r.h.

Standards

Test standards	AS/NZS 3350.2.80: 1998 Amdts 1-3 "Electrical Fan"
Test Report no	SD2443
EMC Compliance	This is a Level One product with an C frame motor that has a very low risk of causing EMC Interference

General

Free Air Fan Performance	286m ³ / hr 79.4L/sec
Installed decibel rating	47DB

Ordering

When ordering please give name and type,	
Reference	FV150
Barcode	942000490013-6

Technical Data

Power Supply	230 VAC
Power consumption	max. 0.3 Amps
Supply Line fusing	max. 10A
For solid wires	2 x 1.5mm ²
Motor	230-240VAC 50Hz 0,4Amp
Motor insulation class	B1
Total motor wattage	30Watts
Motor protection	Impedance protected
Total product wattage	30 watts