

Technical Data Sheet

WEISS™

FV603

3 Room Heat Transfer

with Thermostat

Dimensions

Cut-out size for inlet fascia 247mm

Cut out size for outlet fascia 155mm

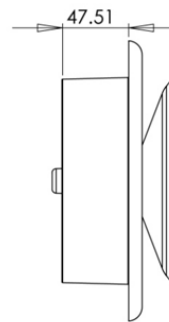
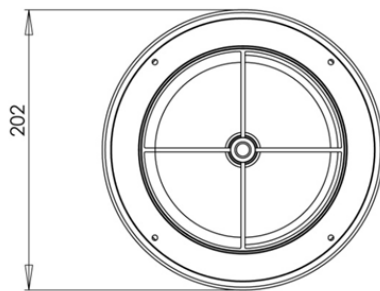
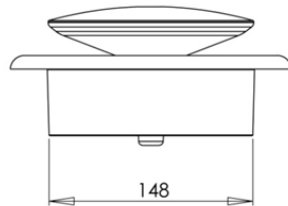
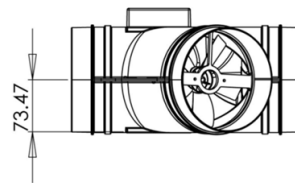
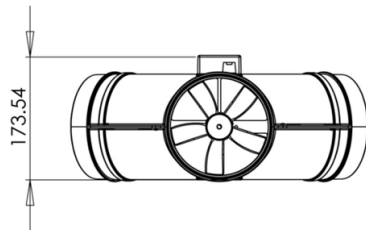
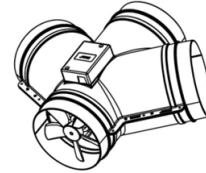
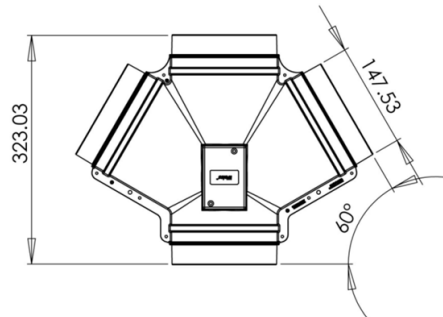

Specifications

Weight	10.8kg
Colour of front fascia	White
Housing material	FR ABS

Approval

AS/NZS 3350.2.80:1998 Amdts 1-3 "Electrical Fan"

Features

- Easy to install
- 15 metres of 150mm insulated ducting supplied
- Unique 'no fuss' all in one unit
- Thermostat included
- Allows warmth to be moved around your home
- Effective temperature control for your home
- All parts are included
- 3 year extended warranty

Technical Data Sheet

Product Use

The FV603 is used for the transfer of heat

Typical applications:

- Bedrooms
- Lounges
- Living areas

Environmental Conditions

Operation	to IEC 721-3-3
Climatic conditions	class 3K5
Temperature	0...+50°C
Humidity	<95% r.h.

Standards

Test standards	AS/NZS 3350.2.80: 1998 Amdts 1-3 "Electrical Fan"
Test Report no EMC Compliance	SD3175A This is a Level One product with an External rotor motor that has a very low risk of causing EMC Interference

General

Free Air Fan Performance	420m ³ /hr 116.6L/sec
Installed decibel rating	42DB

Ordering

When ordering please give name and type,	
Reference	FV603
Barcode	942000490021-1

Technical Data

Power Supply	230 VAC
Power consumption	max. 0.75 Amps
Supply Line fusing	max. 10A
For solid wires	2 x 1.5mm ²
Motor	230-240VAC 50Hz 0.4 Amp
Motor insulation class	B
Total motor wattage	120 Watts
Motor protection	Impedance protected